

WD-101 JEZDNIA LEWA

ANTYKOROZJA									
BARIERY									
NAWIERZCHNIA									
ASFALT TWARDOLANY									
KAPY CHODNIKOWE									
KRAWĘŻNIKI									
IZOLACJA ARKUSZOWA									

1L

2L

3L

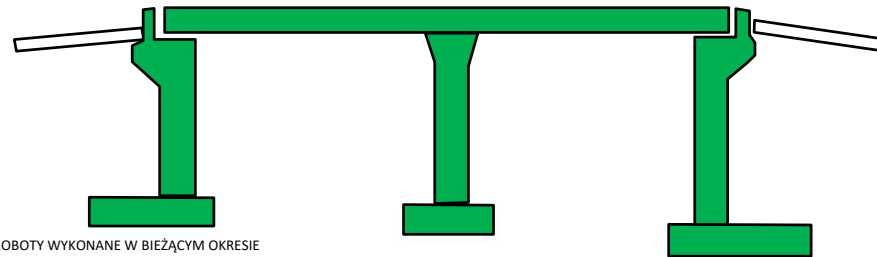

LEGENDA:

- ROBOTY WYKONANE W BIEŻĄCYM OKRESIE
- ROBOTY WYKONANE DO BIEŻĄCEGO OKRESU
- ROBOTY W TOKU W BIEŻĄCYM OKRESIE

WD-101 JEZDNIA PRAWA

ANTYKOROZJA									
BARIERY									
NAWIERZCHNIA									
ASFALT TWARDOLANY									
KAPY CHODNIKOWE									
KRAWĘŻNIKI									
IZOLACJA ARKUSZOWA									

1P

2P

3P

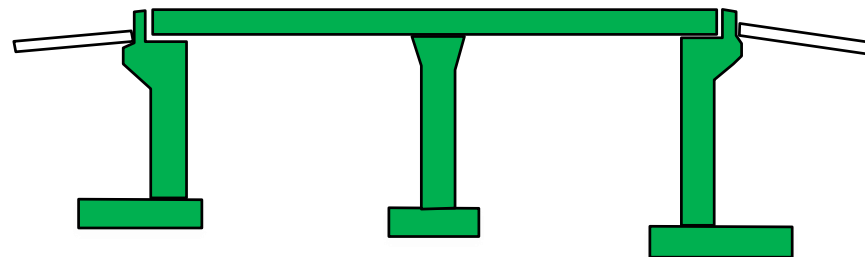

LEGENDA:



- ROBOTY WYKONANE W BIEŻĄCYM OKRESIE
- ROBOTY WYKONANE DO BIEŻĄCEGO OKRESU
- ROBOTY W TOKU W BIEŻĄCYM OKRESIE

WD-101a JEZDNIA LEWA

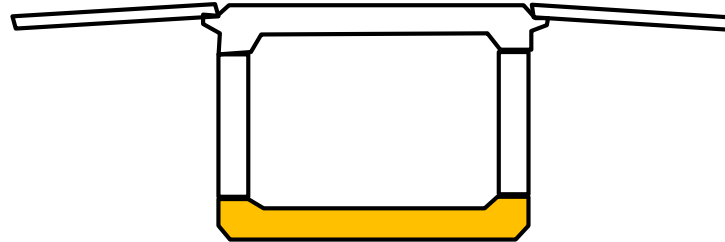
ANTYKOROZJA			
IZOLACJA			



LEGENDA:

-  ROBOTY W TOKU W BIEŻĄCYM OKRESIE
-  ROBOTY WYKONANE W BIEŻĄCYM OKRESIE
-  ROBOTY WYKONANE DO BIEŻĄCEGO OKRESU

WD-101a JEZDNIA PRAWA

ANTYKOROZJA			
IZOLACJA			

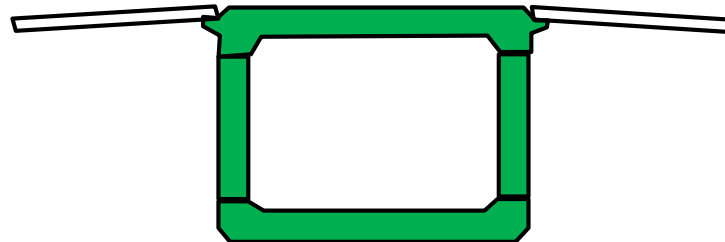

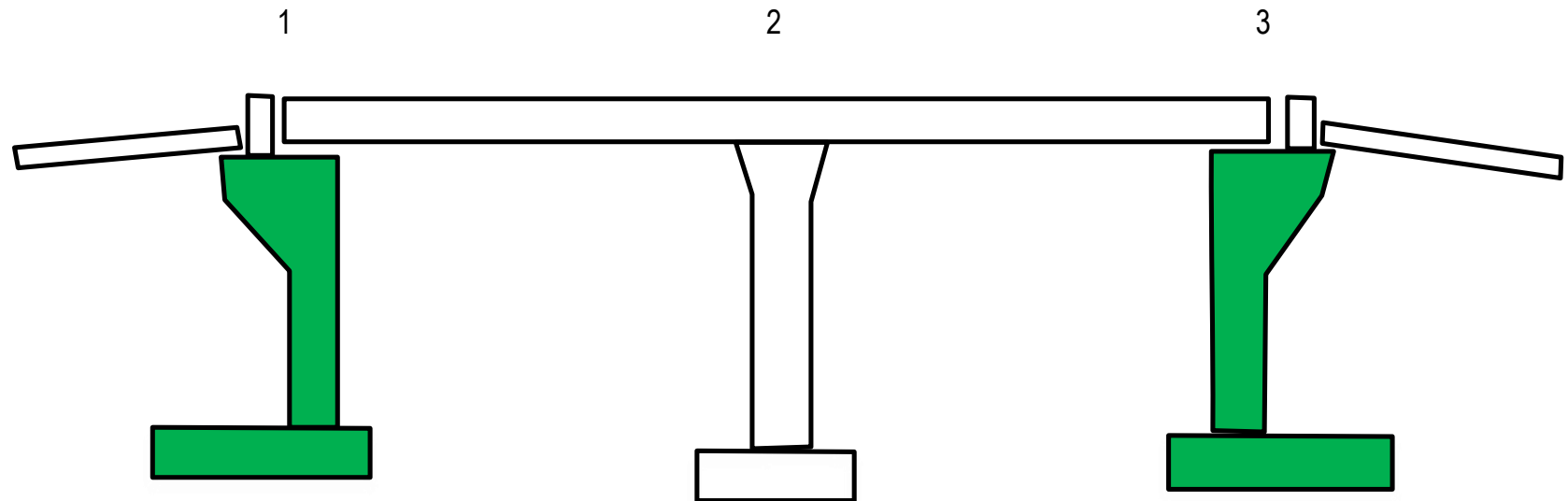

WD-106

ANTYKOROZJA																			
BARIERY																			
NAWIERZCHNIA																			
ASFALT TWARDOLANY																			
KAPY CHODNIKOWE																			
KRAWĘŻNIKI																			
IZOLACJA ARKUSZOWA																			



LEGENDA:

-  ROBOTY WYKONANE W BIEŻĄCYM OKRESIE
-  ROBOTY WYKONANE DO BIEŻĄCEGO OKRESU
-  ROBOTY W TOKU W BIEŻĄCYM OKRESIE

WD-107 JEZDNIA LEWA

LEGENDA:

- ROBOTY WYKONANE W BIEŻĄCYM OKRESIE
- ROBOTY WYKONANE DO BIEŻĄCEGO OKRESU
- ROBOTY W TOKU W BIEŻĄCYM OKRESIE

ANTYKOROZJA																				
BARIERY																				
NAWIERZCHNIA																				
ASFALT TWARDOLANY																				
KAPY CHODNIKOWE																				
KRAWĘŻNIKI																				
IZOLACJA ARKUSZOWA																				

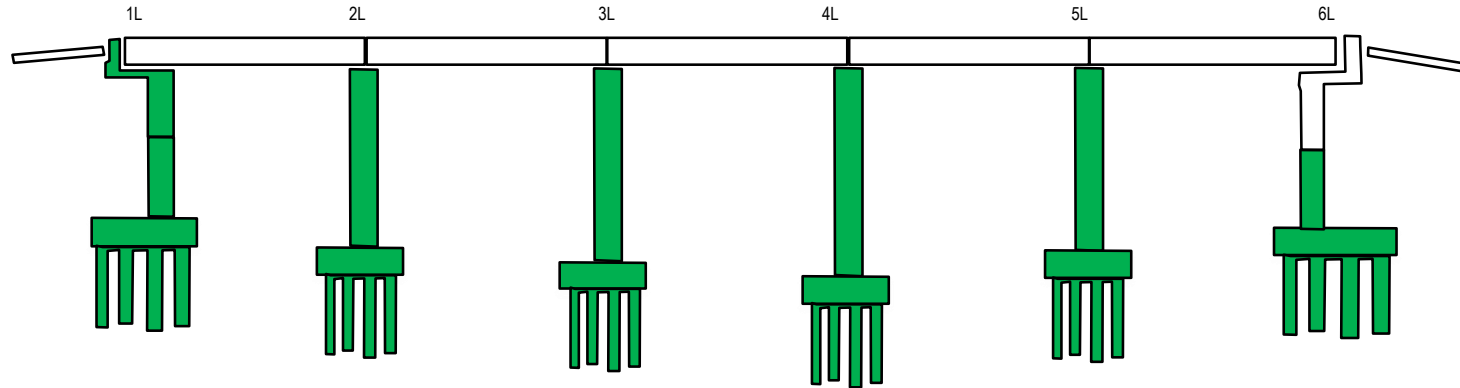

WD-107 JEZDNIA PRAWA

LEGENDA:

- ROBOTY WYKONANE W BIEŻĄCYM OKRESIE
- ROBOTY WYKONANE DO BIEŻĄCEGO OKRESU
- ROBOTY W TOKU W BIEŻĄCYM OKRESIE

ANTYKOROZJA																				
BARIERY																				
NAWIERZCHNIA																				
ASFALT TWARDOLANY																				
KAPY CHODNIKOWE																				
KRAWĘŻNIKI																				
IZOLACJA ARKUSZOWA																				

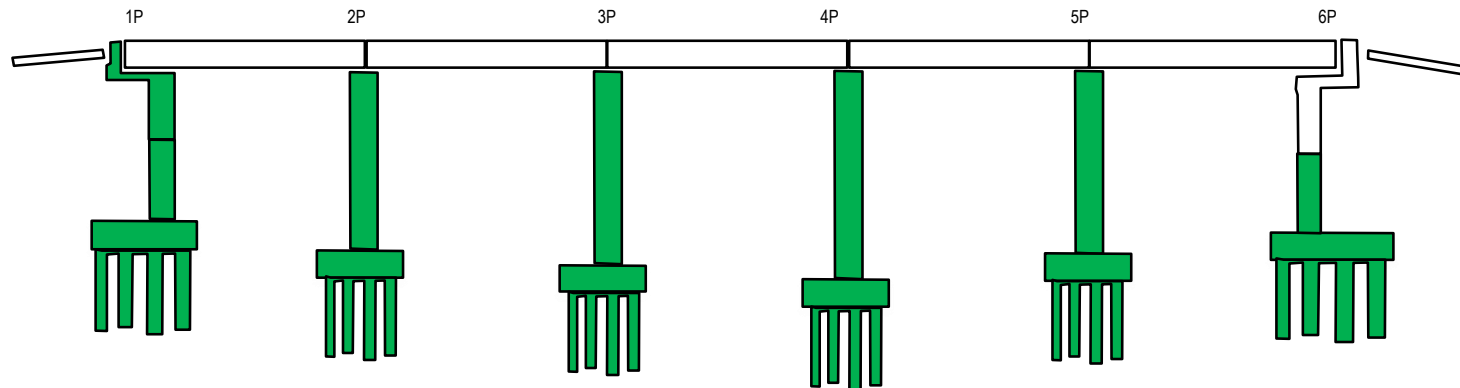

WD-108 Jezdnia Lewa

ANTYKOROZJA							
BARIERY							
NAWIERZCHNIA							
ASFALT TWARDOLANY							
KAPY CHODNIKOWE							
KRAWĘŻNIKI							
IZOLACJA ARKUSZOWA							

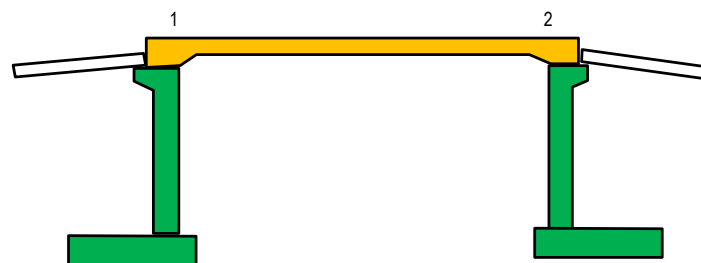

LEGENDA:

- ROBOTY WYKONANE W BIEŻĄCYM OKRESIE
- ROBOTY WYKONANE DO BIEŻĄCEGO OKRESU
- ROBOTY W TOKU W BIEŻĄCYM OKRESIE

WD-108 Jezdnia Prawa

ANTYKOROZJA							
BARIERY							
NAWIERZCHNIA							
ASFALT TWARDOLANY							
KAPY CHODNIKOWE							
KRAWĘŻNIKI							
IZOLACJA ARKUSZOWA							



LEGENDA:

- ROBOTY WYKONANE W BIEŻĄCYM OKRESIE
- ROBOTY WYKONANE DO BIEŻĄCEGO OKRESU
- ROBOTY W TOKU W BIEŻĄCYM OKRESIE

WD-109 JEZDNIA LEWA

ANTYKOROZJA																				
BARIERY																				
NAWIERZCHNIA																				
ASFALT TWARDOLANY																				
KAPY CHODNIKOWE																				
KRAWĘŻNIKI																				
IZOLACJA ARKUSZOWA																				

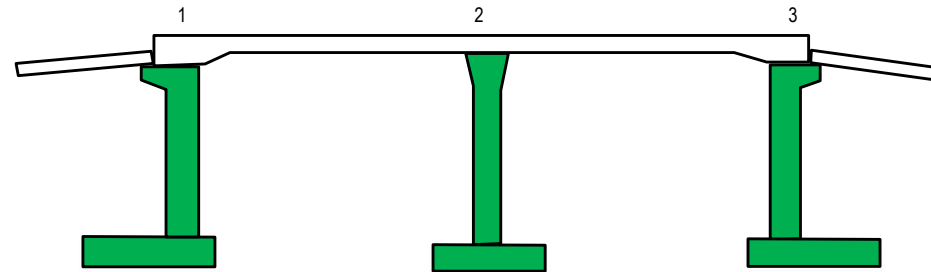

LEGENDA:

- ROBOTY WYKONANE W BIEŻĄCYM OKRESIE
- ROBOTY WYKONANE DO BIEŻĄCEGO OKRESU
- ROBOTY W TOKU W BIEŻĄCYM OKRESIE

WD-109 JEZDNIA PRAWA

ANTYKOROZJA																				
BARIERY																				
NAWIERZCHNIA																				
ASFALT TWARDOLANY																				
KAPY CHODNIKOWE																				
KRAWĘŻNIKI																				
IZOLACJA ARKUSZOWA																				

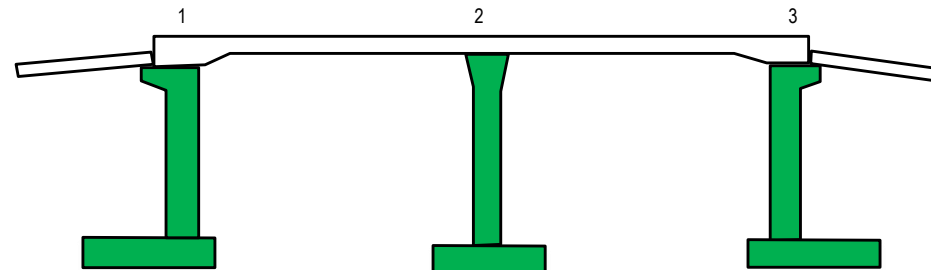

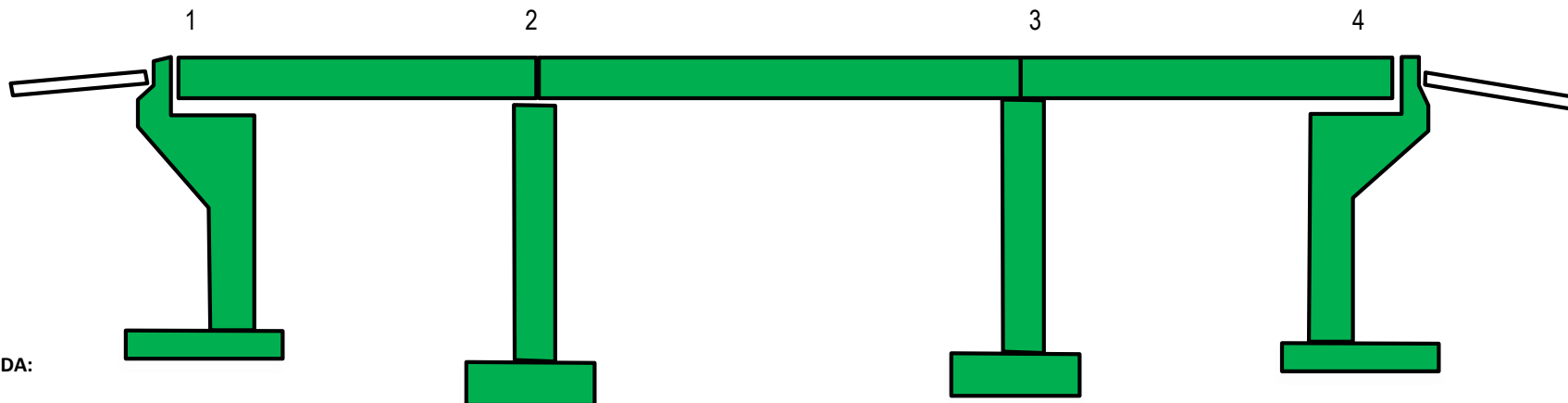

WD-110

ANTYKOROZJA													
BARIERY													
NAWIERZCHNIA													
ASFALT TWARDOLANY													
KAPY CHODNIKOWE													
KRAWĘŻNIKI													
IZOLACJA ARKUSZOWA													



LEGENDA:

-  ROBOTY WYKONANE W BIEŻĄCYM OKRESIE
-  ROBOTY WYKONANE DO BIEŻĄCEGO OKRESU
-  ROBOTY W TOKU W BIEŻĄCYM OKRESIE

WD-111 JEZDNIA LEWA

ANTYKOROZJA							
BARIERY							
NAWIERZCHNIA							
ASFALT TWARDOLANY							
KAPY CHODNIKOWE							
KRAWĘŻNIKI							
IZOLACJA ARKUSZOWA							

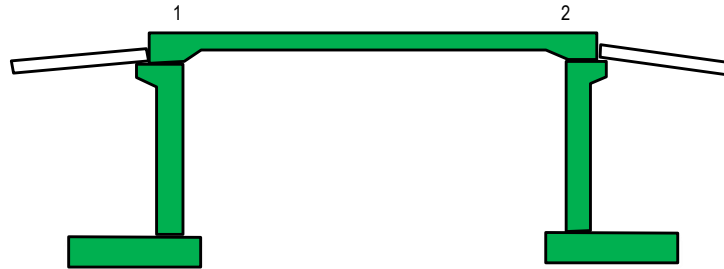

LEGENDA:

- ROBOTY W TOKU W BIEŻĄCYM OKRESIE
- ROBOTY WYKONANE W BIEŻĄCYM OKRESIE
- ROBOTY WYKONANE DO BIEŻĄCEGO OKRESU

WD-111 JEZDNIA PRAWA

ANTYKOROZJA							
BARIERY							
NAWIERZCHNIA							
ASFALT TWARDOLANY							
KAPY CHODNIKOWE							
KRAWĘŻNIKI							
IZOLACJA ARKUSZOWA							

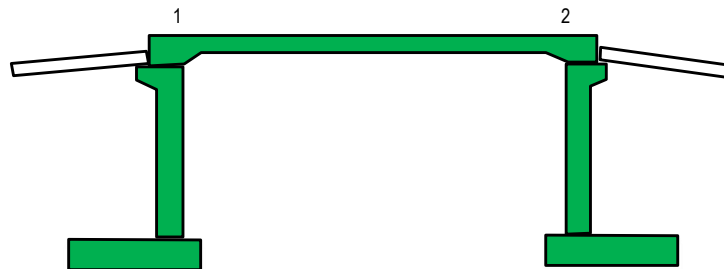

WD-113 JEZDNIĄ LEWA

ANTYKOROZJA																			
BARIERY																			
NAWIERZCHNIA																			
ASFALT TWARDOŁANY																			
KAPY CHODNIKOWE																			
KRAWĘŻNIKI																			
IZOLACJA ARKUSZOWA																			

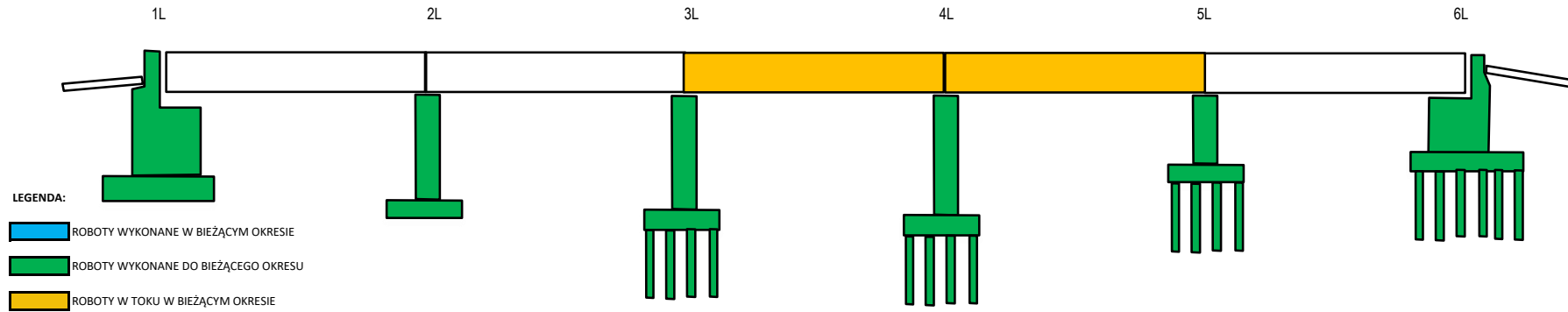

WD-113 JEZDNIĄ PRAWA

ANTYKOROZJA																			
BARIERY																			
NAWIERZCHNIA																			
ASFALT TWARDOŁANY																			
KAPY CHODNIKOWE																			
KRAWĘŻNIKI																			
IZOLACJA ARKUSZOWA																			

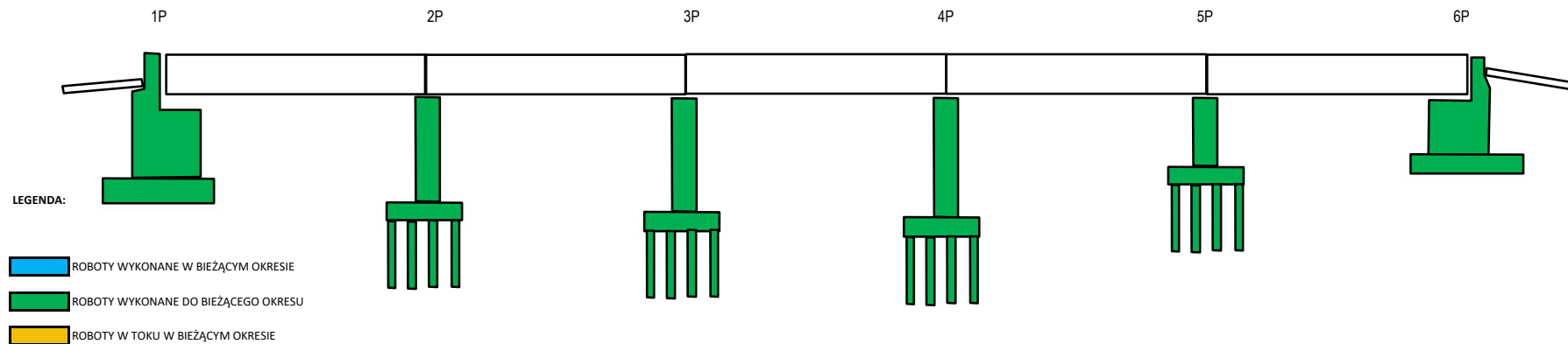

WD-113A

ANTYKOROZJA																				
BARIERY																				
NAWIERZCHNIA																				
ASFALT TWARDOŁANY																				
KAPY CHODNIKOWE																				
KRAWĘŻNIKI																				
IZOLACJA ARKUSZOWA																				

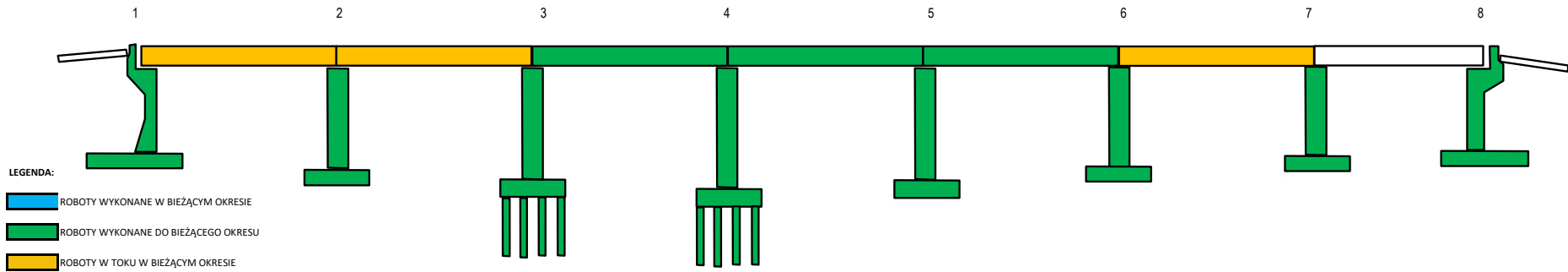

WD-113B

ANTYKOROZJA												
BARIERY												
NAWIERZCHNIA												
ASFALT TWARDOLANY												
KAPY CHODNIKOWE												
KRAWĘŻNIKI												
IZOLACJA ARKUSZOWA												

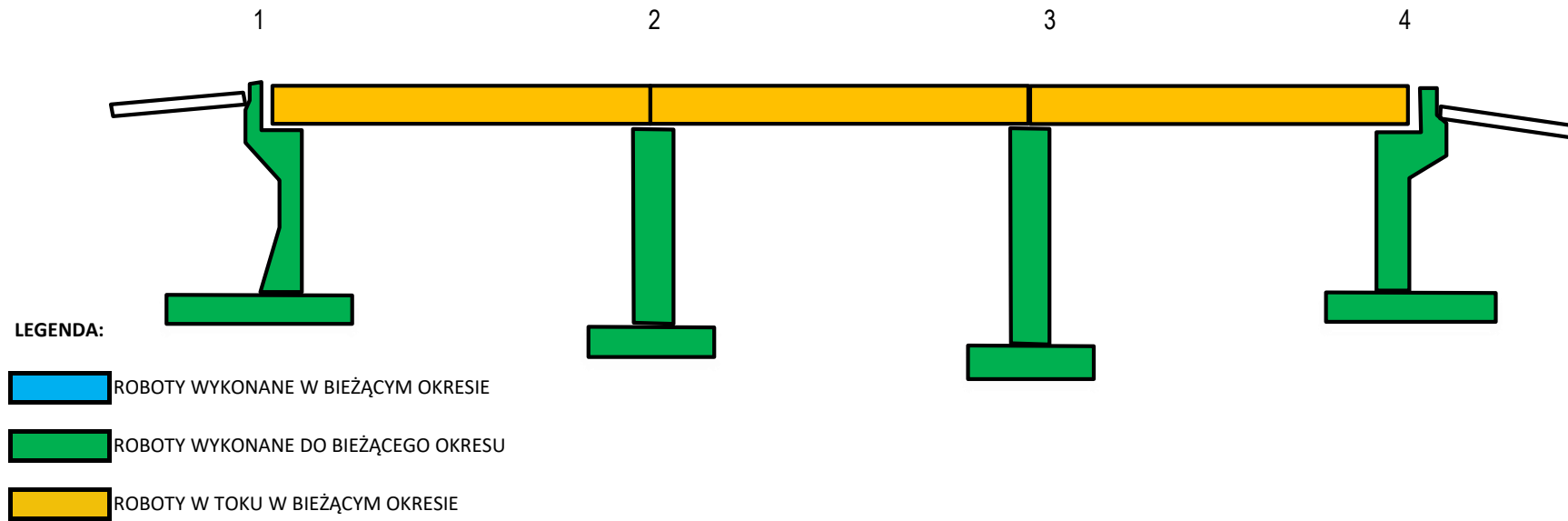

WD-114

ANTYKOROZJA										
BARIERY										
NAWIERZCHNIA										
ASFALT TWARDOLANY										
KAPY CHODNIKOWE										
KRAWĘŻNIKI										
IZOLACJA ARKUSZOWA										

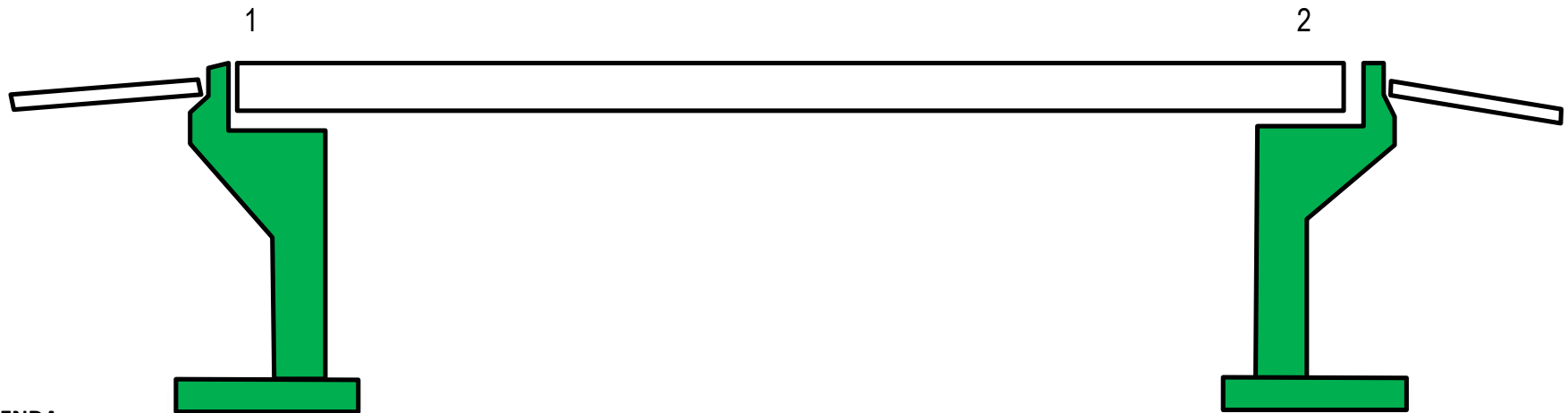

LEGENDA:

 ROBOTY WYKONANE W BIEŻĄCYM OKRESIE

 ROBOTY WYKONANE DO BIEŻĄCEGO OKRESU

 ROBOTY W TOKU W BIEŻĄCYM OKRESIE

WD-115 strona prawa

ANTYKOROZJA									
BARIERY									
NAWIERZCHNIA									
ASFALT TWARDOLANY									
KAPY CHODNIKOWE									
KRAWĘŻNIKI									
IZOLACJA ARKUSZOWA									



LEGENDA:

- ROBOTY WYKONANE W BIEŻĄCYM OKRESIE
- ROBOTY WYKONANE DO BIEŻĄCEGO OKRESU
- ROBOTY W TOKU W BIEŻĄCYM OKRESIE

WD-115 strona lewa

ANTYKOROZJA									
BARIERY									
NAWIERZCHNIA									
ASFALT TWARDOLANY									
KAPY CHODNIKOWE									
KRAWĘŻNIKI									
IZOLACJA ARKUSZOWA									



LEGENDA:

- ROBOTY WYKONANE W BIEŻĄCYM OKRESIE
- ROBOTY WYKONANE DO BIEŻĄCEGO OKRESU
- ROBOTY W TOKU W BIEŻĄCYM OKRESIE

WD-116 JEZDZIA LEWA

ANTYKOROZJA											
BARIERY											
NAWIERZCHNIA											
ASFALT TWARDOLANY											
KAPY CHODNIKOWE											
KRAWĘŻNIKI											
IZOLACJA ARKUSZOWA											

1L

2L

3L

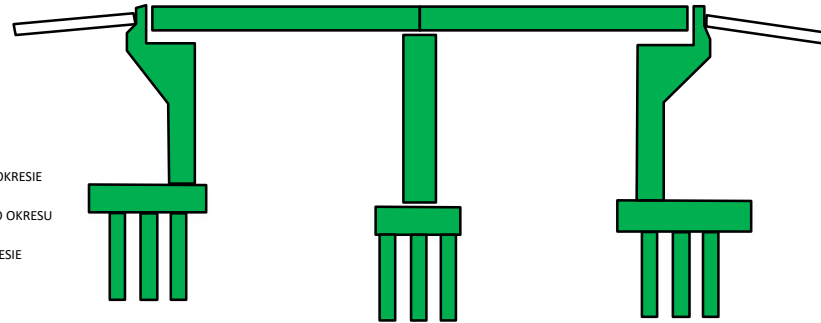

LEGENDA:

- ROBOTY WYKONANE W BIEŻĄCYM OKRESIE
- ROBOTY WYKONANE DO BIEŻĄCEGO OKRESU
- ROBOTY W TOKU W BIEŻĄCYM OKRESIE

WD-116 JEZDZIA PRAWA

ANTYKOROZJA											
BARIERY											
NAWIERZCHNIA											
ASFALT TWARDOLANY											
KAPY CHODNIKOWE											
KRAWĘŻNIKI											
IZOLACJA ARKUSZOWA											

1P

2P

3P

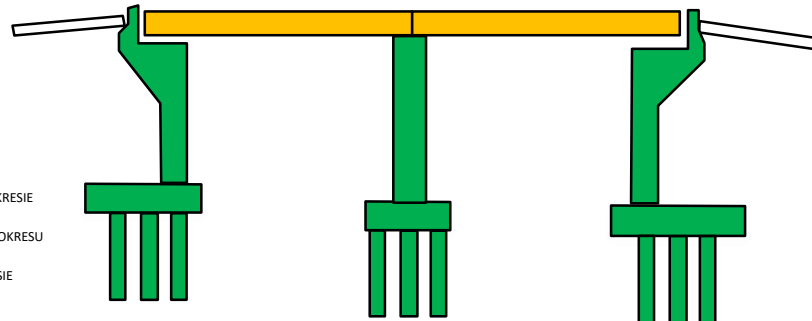

LEGENDA:

- ROBOTY WYKONANE W BIEŻĄCYM OKRESIE
- ROBOTY WYKONANE DO BIEŻĄCEGO OKRESU
- ROBOTY W TOKU W BIEŻĄCYM OKRESIE

WD-117 JEZDNIA LEWA

LEGENDA:

- ROBOTY WYKONANE W BIEŻĄCYM OKRESIE
- ROBOTY WYKONANE DO BIEŻĄCEGO OKRESU
- ROBOTY W TOKU W BIEŻĄCYM OKRESIE

ANTYKOROZJA																			
BARIERY																			
NAWIERZCHNIA																			
ASFALT TWARDOLANY																			
KAPY CHODNIKOWE																			
KRAWĘŻNIKI																			
IZOLACJA ARKUSZOWA																			

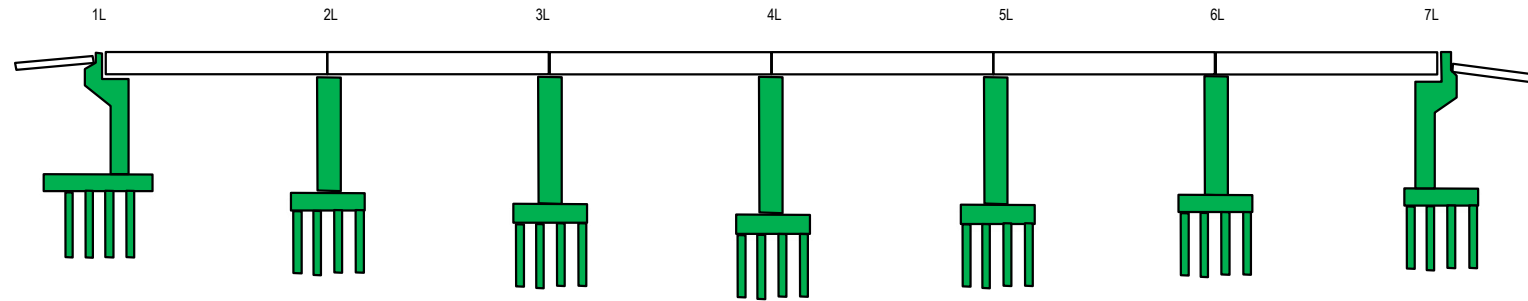

WD-117 JEZDNIA PRAWA

LEGENDA:

- ROBOTY WYKONANE W BIEŻĄCYM OKRESIE
- ROBOTY WYKONANE DO BIEŻĄCEGO OKRESU
- ROBOTY W TOKU W BIEŻĄCYM OKRESIE

ANTYKOROZJA																			
BARIERY																			
NAWIERZCHNIA																			
ASFALT TWARDOLANY																			
KAPY CHODNIKOWE																			
KRAWĘŻNIKI																			
IZOLACJA ARKUSZOWA																			

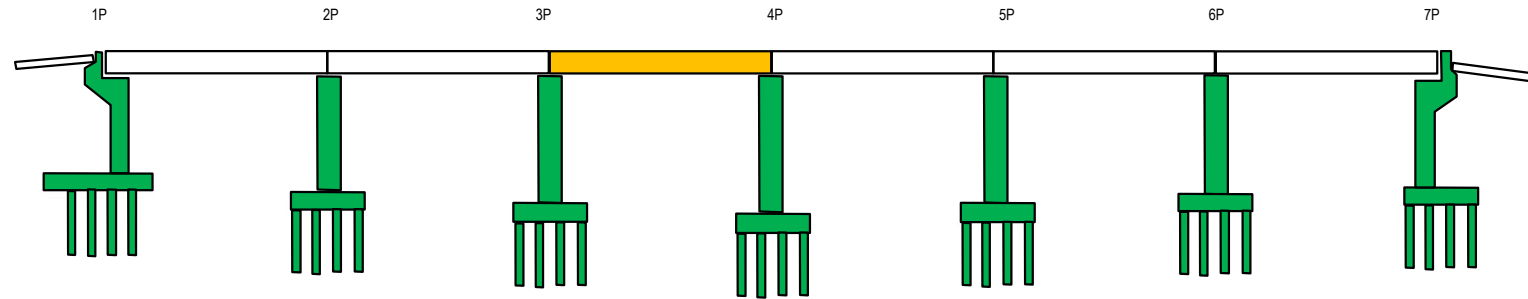

WD-118 JEZDNIA LEWA

ANTYKOROZJA											
BARIERY											
NAWIERZCHNIA											
ASFALT TWARDOLANY											
KAPY CHODNIKOWE											
KRAWĘŻNIKI											
IZOLACJA ARKUSZOWA											



LEGENDA:

- ROBOTY WYKONANE W BIEŻĄCYM OKRESIE
- ROBOTY WYKONANE DO BIEŻĄCEGO OKRESU
- ROBOTY W TOKU W BIEŻĄCYM OKRESIE

WD-118 JEZDNIA PRAWA

ANTYKOROZJA											
BARIERY											
NAWIERZCHNIA											
ASFALT TWARDOLANY											
KAPY CHODNIKOWE											
KRAWĘŻNIKI											
IZOLACJA ARKUSZOWA											



MD-119 JEZDNIA LEWA

LEGENDA:

- ROBOTY WYKONANE W BIEŻĄCYM OKRESIE
- ROBOTY WYKONANE DO BIEŻĄCEGO OKRESU
- ROBOTY W TOKU W BIEŻĄCYM OKRESIE

ANTYKOROZJA										
BARIERY										
NAWIERZCHNIA										
ASFALT TWARDOLANY										
KAPY CHODNIKOWE										
KRAWĘŻNIKI										
IZOLACJA ARKUSZOWA										

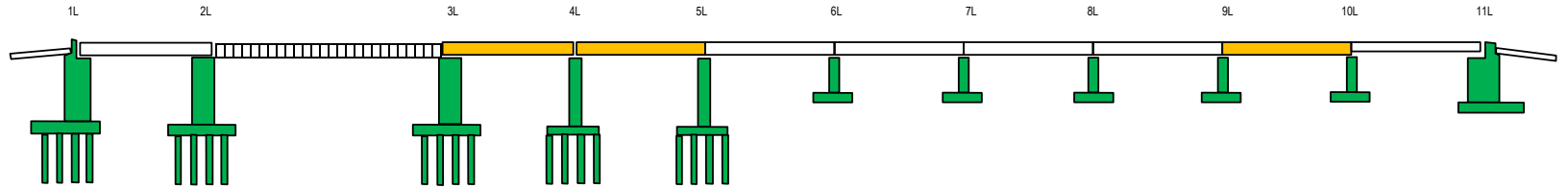

MD-119 JEZDNIA PRAWA

LEGENDA:

- ROBOTY WYKONANE W BIEŻĄCYM OKRESIE
- ROBOTY WYKONANE DO BIEŻĄCEGO OKRESU
- ROBOTY W TOKU W BIEŻĄCYM OKRESIE

ANTYKOROZJA										
BARIERY										
NAWIERZCHNIA										
ASFALT TWARDOLANY										
KAPY CHODNIKOWE										
KRAWĘŻNIKI										
IZOLACJA ARKUSZOWA										

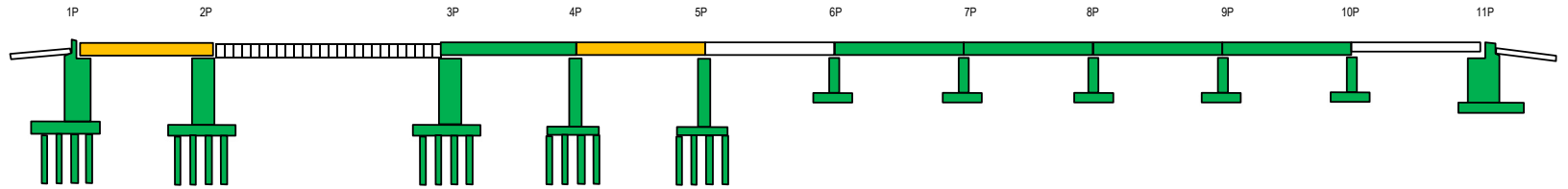

WD-120 strona lewa

ANTYKOROZJA									
BARIERY									
NAWIERZCHNIA									
ASFALT TWARDOLANY									
KAPY CHODNIKOWE									
KRAWĘŻNIKI									
IZOLACJA ARKUSZOWA									

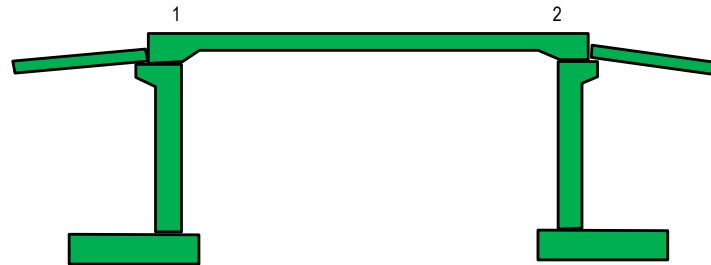

LEGENDA:

- ROBOTY WYKONANE W BIEŻĄCYM OKRESIE
- ROBOTY WYKONANE DO BIEŻĄCEGO OKRESU
- ROBOTY W TOKU W BIEŻĄCYM OKRESIE

WD-120 strona prawa

ANTYKOROZJA									
BARIERY									
NAWIERZCHNIA									
ASFALT TWARDOLANY									
KAPY CHODNIKOWE									
KRAWĘŻNIKI									
IZOLACJA ARKUSZOWA									

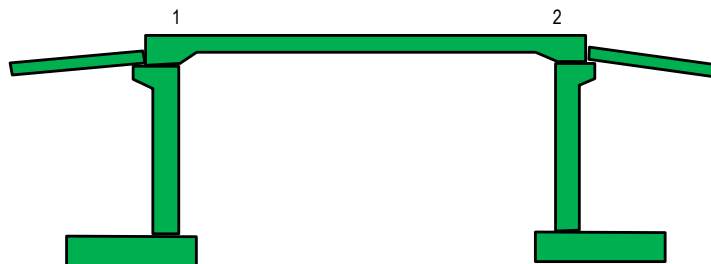

WD-121 JEZDNIA LEWA - GRAFICZNY POSTĘP ROBÓT

ANTYKOROZJA																			
BARIERY																			
NAWIERZCHNIA																			
ASFALT TWARDOLANY																			
KAPY CHODNIKOWE																			
KRAWĘŻNIKI																			
IZOLACJA ARKUSZOWA																			

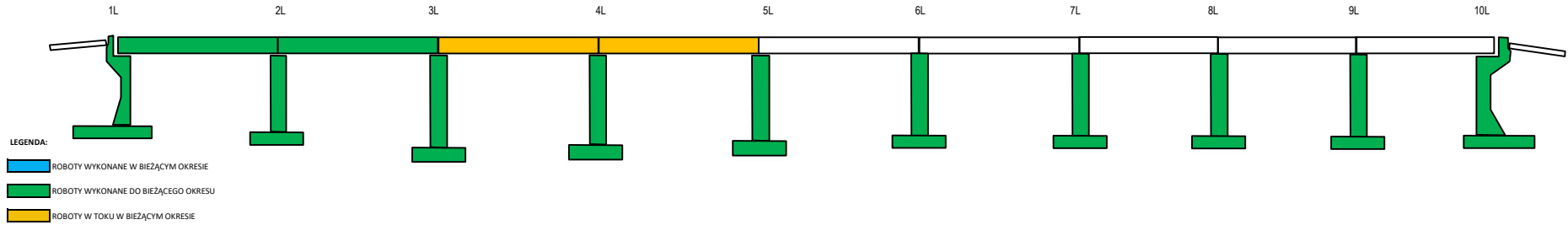

WD-121 JEZDNIA PRAWA - GRAFICZNY POSTĘP ROBÓT

ANTYKOROZJA																			
BARIERY																			
NAWIERZCHNIA																			
ASFALT TWARDOLANY																			
KAPY CHODNIKOWE																			
KRAWĘŻNIKI																			
IZOLACJA ARKUSZOWA																			

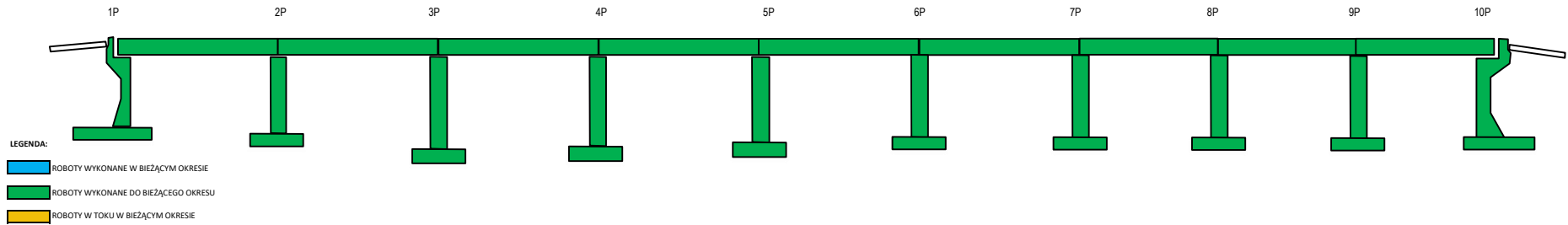

WD-122A

ANTYKOROZJA																			
BARIERY																			
NAWIERZCHNIA																			
ASFALT TWARDOLANY																			
KAPY CHODNIKOWE																			
KRAWĘŻNIKI																			
IZOLACJA ARKUSZOWA																			

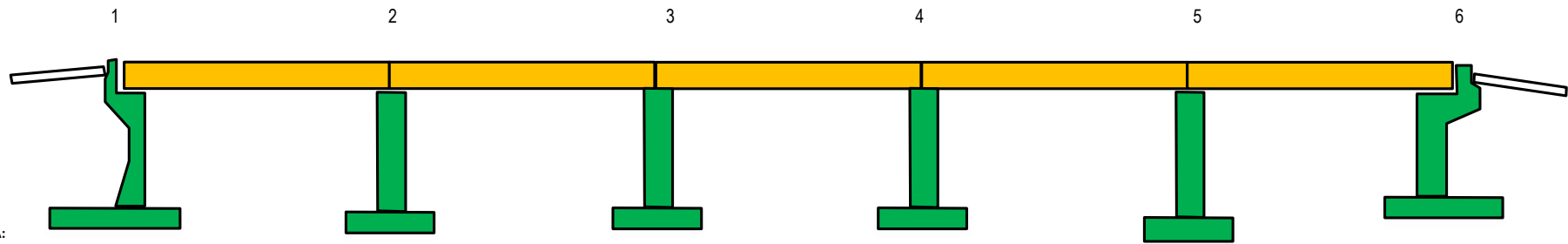

LEGENDA:

- ROBOTY WYKONANE W BIEŻĄCYM OKRESIE
- ROBOTY WYKONANE DO BIEŻĄCEGO OKRESU
- ROBOTY W TOKU W BIEŻĄCYM OKRESIE

WD-122B

ANTYKOROZJA																				
BARIERY																				
NAWIERZCHNIA																				
ASFALT TWARDOLANY																				
KAPY CHODNIKOWE																				
KRAWĘŻNIKI																				
IZOLACJA ARKUSZOWA																				

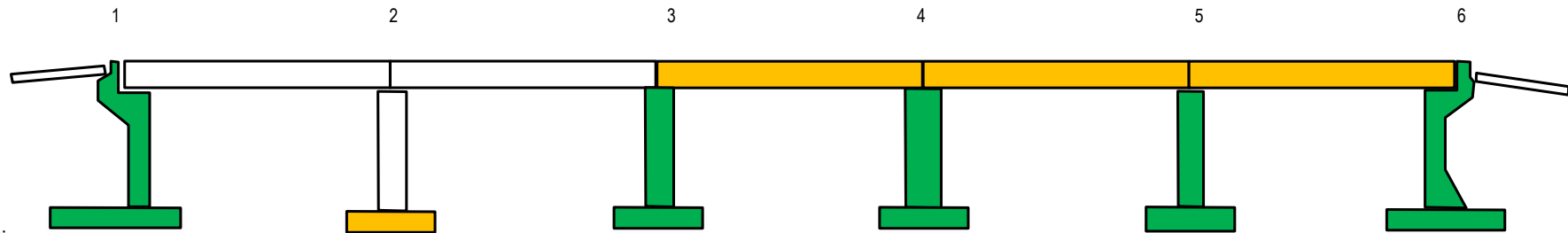

LEGENDA:

- ROBOTY WYKONANE W BIEŻĄCYM OKRESIE
- ROBOTY WYKONANE DO BIEŻĄCEGO OKRESU
- ROBOTY W TOKU W BIEŻĄCYM OKRESIE

WD-122C

ANTYKOROZJA																	
BARIERY																	
NAWIERZCHNIA																	
ASFALT TWARDOLANY																	
KAPY CHODNIKOWE																	
KRAWĘŻNIKI																	
IZOLACJA ARKUSZOWA																	

1

2



3

4

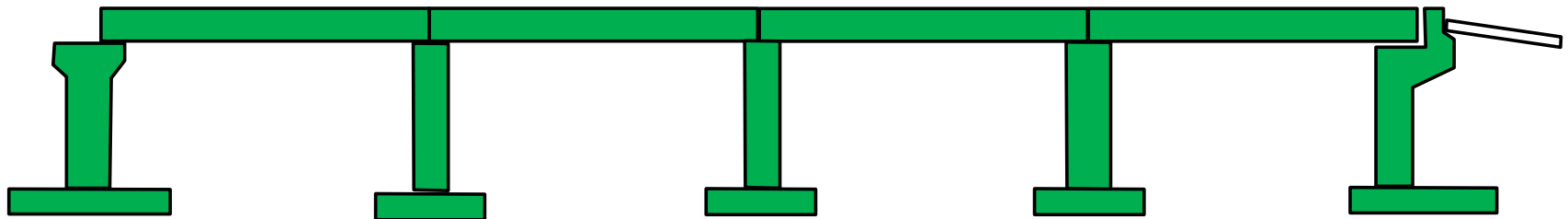
5



LEGENDA:

-  ROBOTY WYKONANE W BIEŻĄCYM OKRESIE
-  ROBOTY WYKONANE DO BIEŻĄCEGO OKRESU
-  ROBOTY W TOKU W BIEŻĄCYM OKRESIE