

## WD-101 JEZDNIA LEWA

ANTYKOROZJA									
BARIERY									
NAWIERZCHNIA									
ASFALT TWARDOLANY									
KAPY CHODNIKOWE									
KRAWĘŻNIKI									
IZOLACJA ARKUSZOWA									

1L

2L

3L

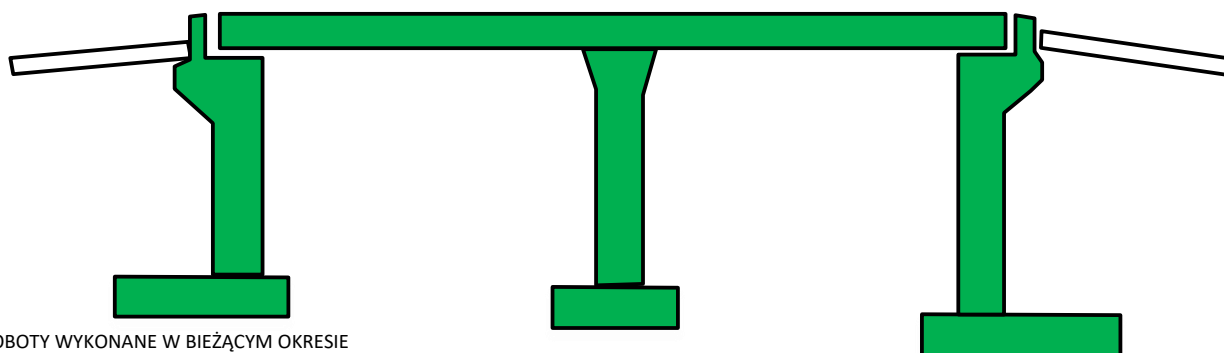

**LEGENDA:**

ROBOTY WYKONANE W BIEŻĄCYM OKRESIE

ROBOTY WYKONANE DO BIEŻĄCEGO OKRESU

ROBOTY W TOKU W BIEŻĄCYM OKRESIE

## WD-101 JEZDNIA PRAWA

ANTYKOROZJA									
BARIERY									
NAWIERZCHNIA									
ASFALT TWARDOLANY									
KAPY CHODNIKOWE									
KRAWĘŻNIKI									
IZOLACJA ARKUSZOWA									

1P

2P

3P

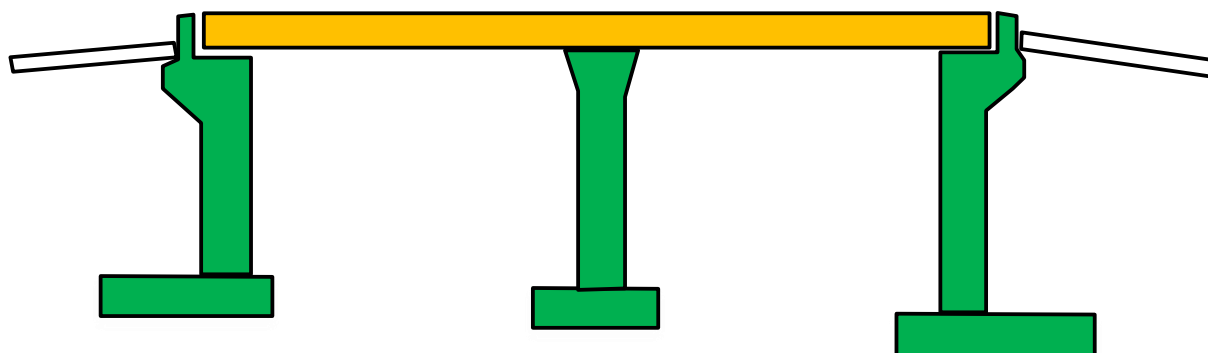

**LEGENDA:**

ROBOTY WYKONANE W BIEŻĄCYM OKRESIE

ROBOTY WYKONANE DO BIEŻĄCEGO OKRESU



ROBOTY W TOKU W BIEŻĄCYM OKRESIE

## WD-101a JEZDNIA LEWA

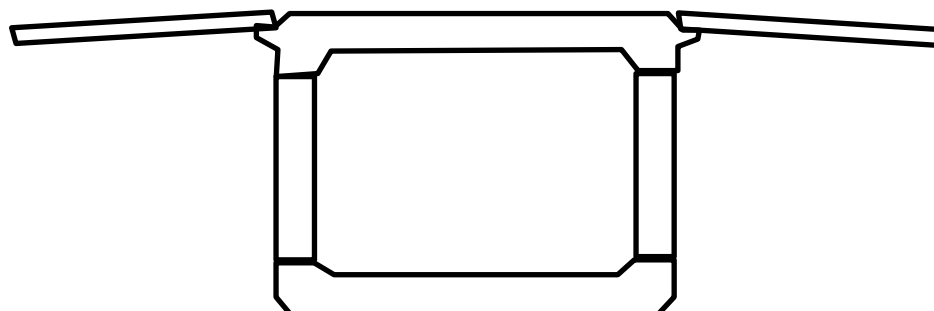
ANTYKOROZJA			
IZOLACJA			



### LEGENDA:

-  ROBOTY W TOKU W BIEŻĄCYM OKRESIE
-  ROBOTY WYKONANE W BIEŻĄCYM OKRESIE
-  ROBOTY WYKONANE DO BIEŻĄCEGO OKRESU

## WD-101a JEZDNIA PRAWA

ANTYKOROZJA			
IZOLACJA			

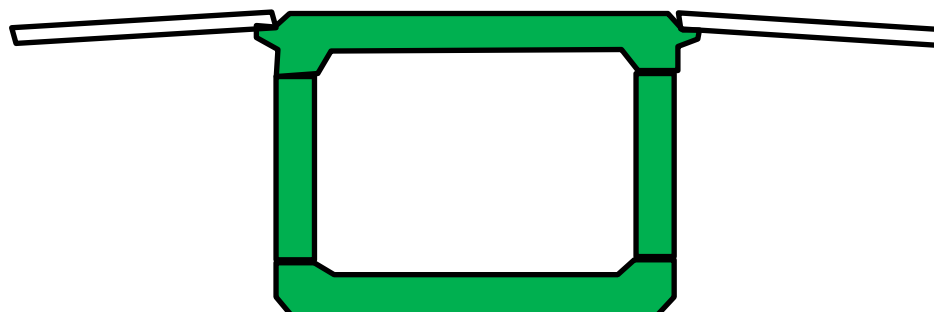





# WD-106

ANTYKOROZJA									
BARIERY									
NAWIERZCHNIA									
ASFALT TWARDOLANY									
KAPY CHODNIKOWE									
KRAWĘŻNIKI									
IZOLACJA ARKUSZOWA									

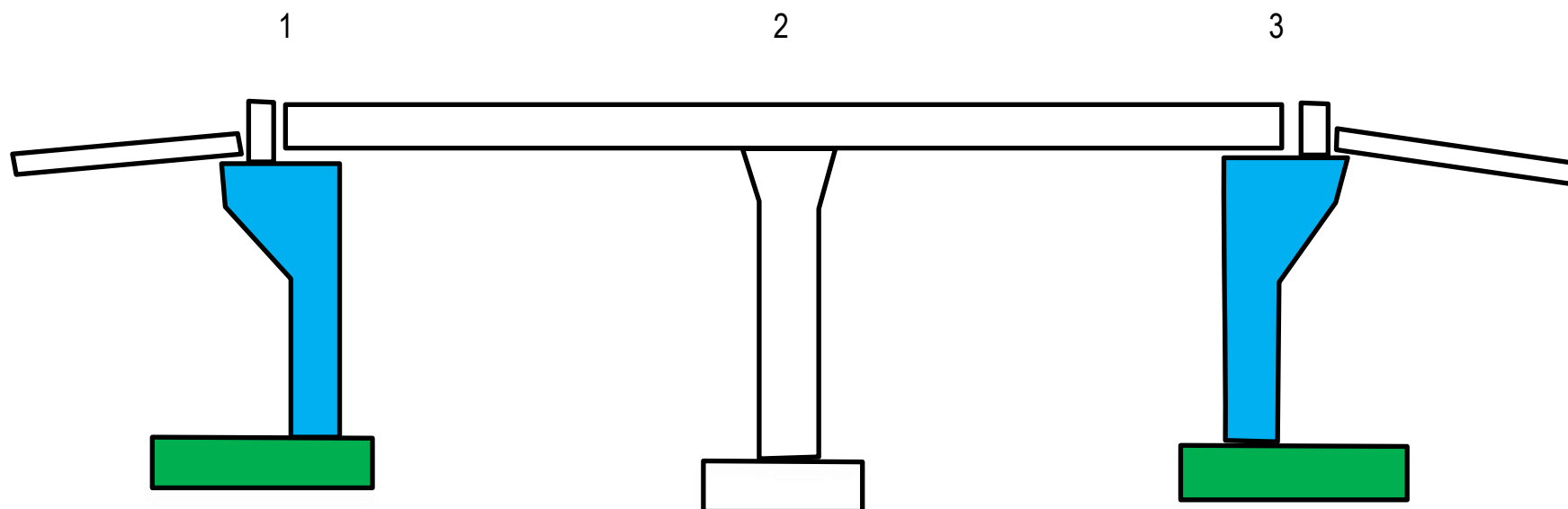

## LEGENDA:

 ROBOTY WYKONANE W BIEŻĄCYM OKRESIE

 ROBOTY WYKONANE DO BIEŻĄCEGO OKRESU

 ROBOTY W TOKU W BIEŻĄCYM OKRESIE

### WD-107 JEZDNIA LEWA

**LEGENDA:**

- ROBOTY WYKONANE W BIEŻĄCYM OKRESIE
- ROBOTY WYKONANE DO BIEŻĄCEGO OKRESU
- ROBOTY W TOKU W BIEŻĄCYM OKRESIE

ANTYKOROZJA																			
BARIERY																			
NAWIERZCHNIA																			
ASFALT TWARDOLANY																			
KAPY CHODNIKOWE																			
KRAWĘŻNIKI																			
IZOLACJA ARKUSZOWA																			

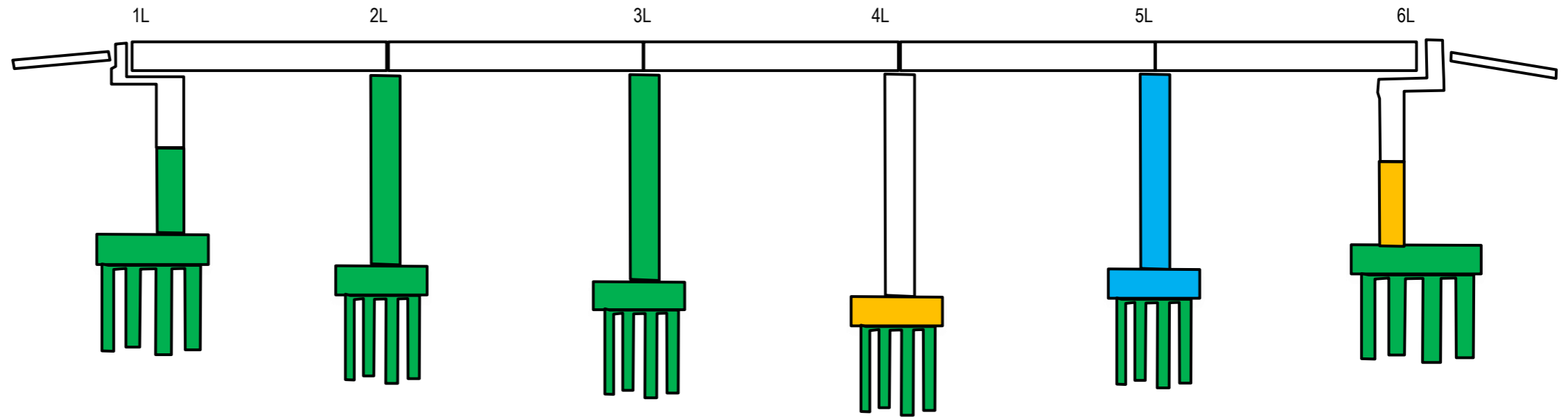

### WD-107 JEZDNIA PRAWA

**LEGENDA:**

- ROBOTY WYKONANE W BIEŻĄCYM OKRESIE
- ROBOTY WYKONANE DO BIEŻĄCEGO OKRESU
- ROBOTY W TOKU W BIEŻĄCYM OKRESIE

ANTYKOROZJA																			
BARIERY																			
NAWIERZCHNIA																			
ASFALT TWARDOLANY																			
KAPY CHODNIKOWE																			
KRAWĘŻNIKI																			
IZOLACJA ARKUSZOWA																			

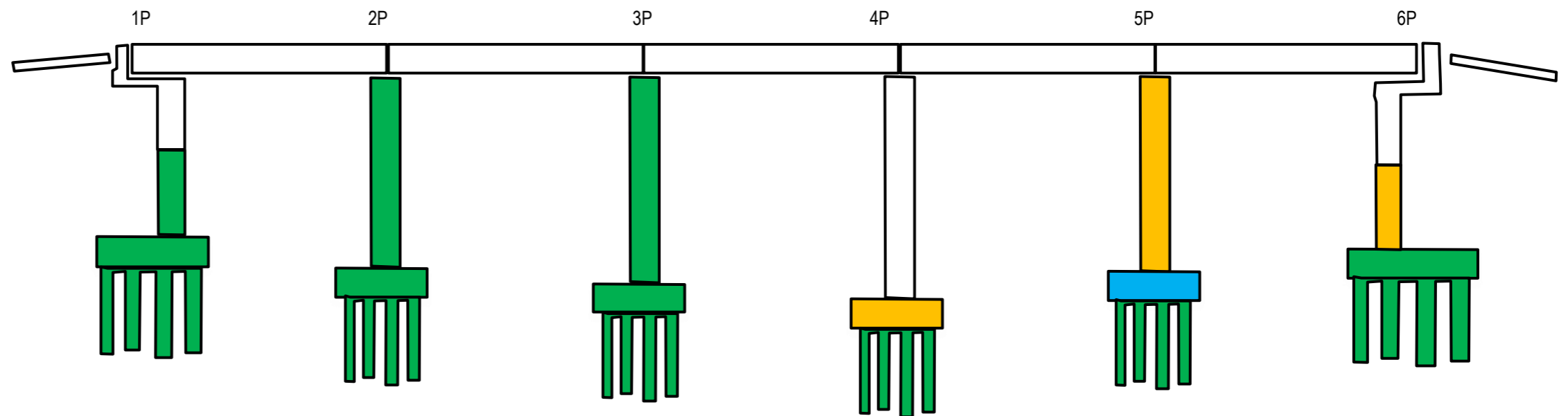

## WD-108 Jezdnia Lewa

ANTYKOROZJA								
BARIERY								
NAWIERZCHNIA								
ASFALT TWARDOLANY								
KAPY CHODNIKOWE								
KRAWĘŻNIKI								
IZOLACJA ARKUSZOWA								



**LEGENDA:**

- ROBOTY WYKONANE W BIEŻĄCYM OKRESIE
- ROBOTY WYKONANE DO BIEŻĄCEGO OKRESU
- ROBOTY W TOKU W BIEŻĄCYM OKRESIE

## WD-108 Jezdnia Prawa

ANTYKOROZJA								
BARIERY								
NAWIERZCHNIA								
ASFALT TWARDOLANY								
KAPY CHODNIKOWE								
KRAWĘŻNIKI								
IZOLACJA ARKUSZOWA								

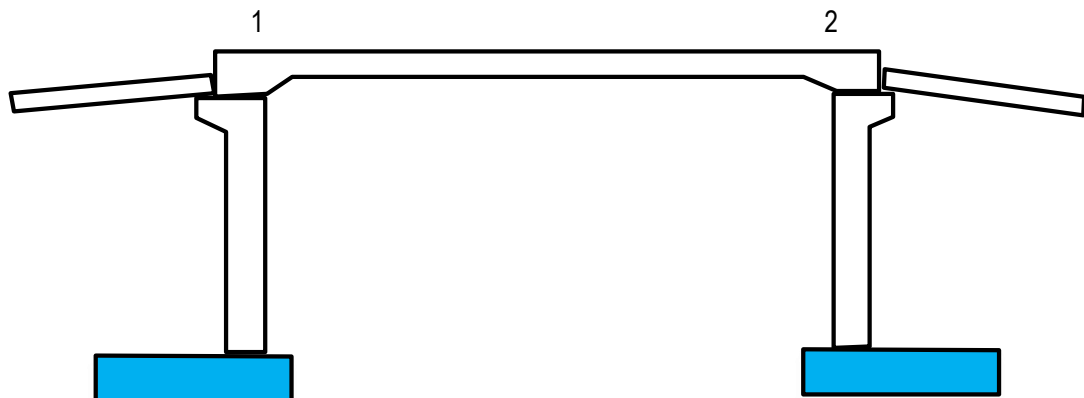

**LEGENDA:**

- ROBOTY WYKONANE W BIEŻĄCYM OKRESIE
- ROBOTY WYKONANE DO BIEŻĄCEGO OKRESU
- ROBOTY W TOKU W BIEŻĄCYM OKRESIE

### WD-109 JEZDNIA LEWA

ANTYKOROZJA									
BARIERY									
NAWIERZCHNIA									
ASFALT TWARDOLANY									
KAPY CHODNIKOWE									
KRAWĘŻNIKI									
IZOLACJA ARKUSZOWA									

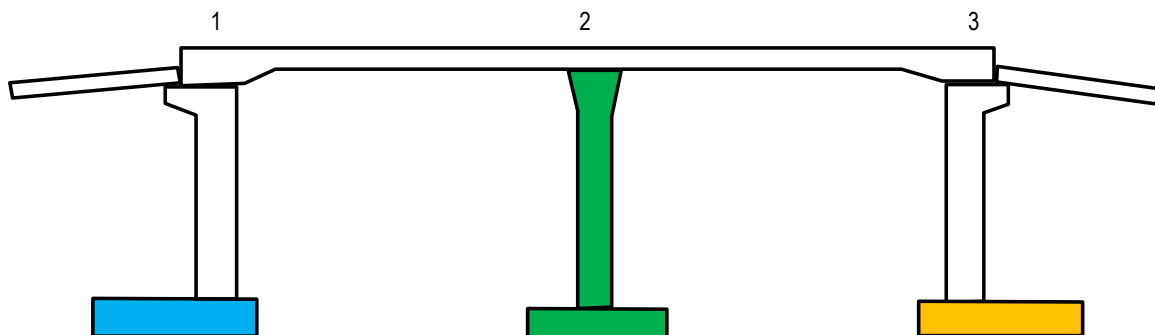

LEGENDA:

- ROBOTY WYKONANE W BIEŻĄCYM OKRESIE
- ROBOTY WYKONANE DO BIEŻĄCEGO OKRESU
- ROBOTY W TOKU W BIEŻĄCYM OKRESIE

### WD-109 JEZDNIA PRAWA

ANTYKOROZJA									
BARIERY									
NAWIERZCHNIA									
ASFALT TWARDOLANY									
KAPY CHODNIKOWE									
KRAWĘŻNIKI									
IZOLACJA ARKUSZOWA									

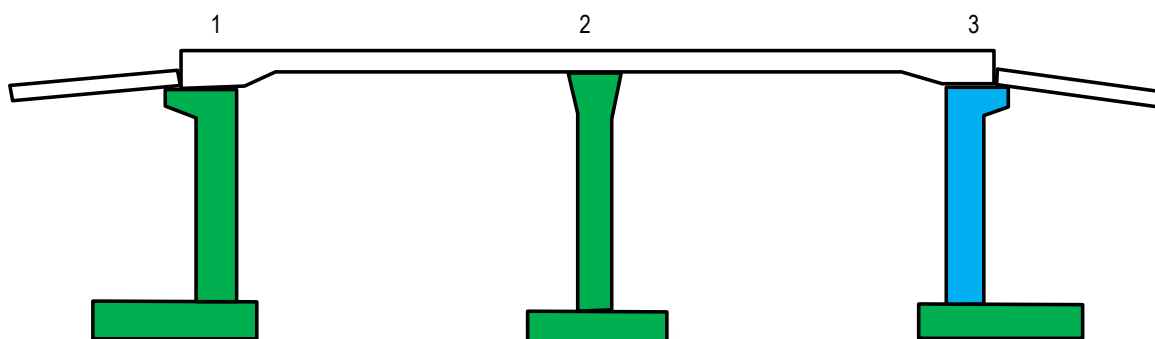



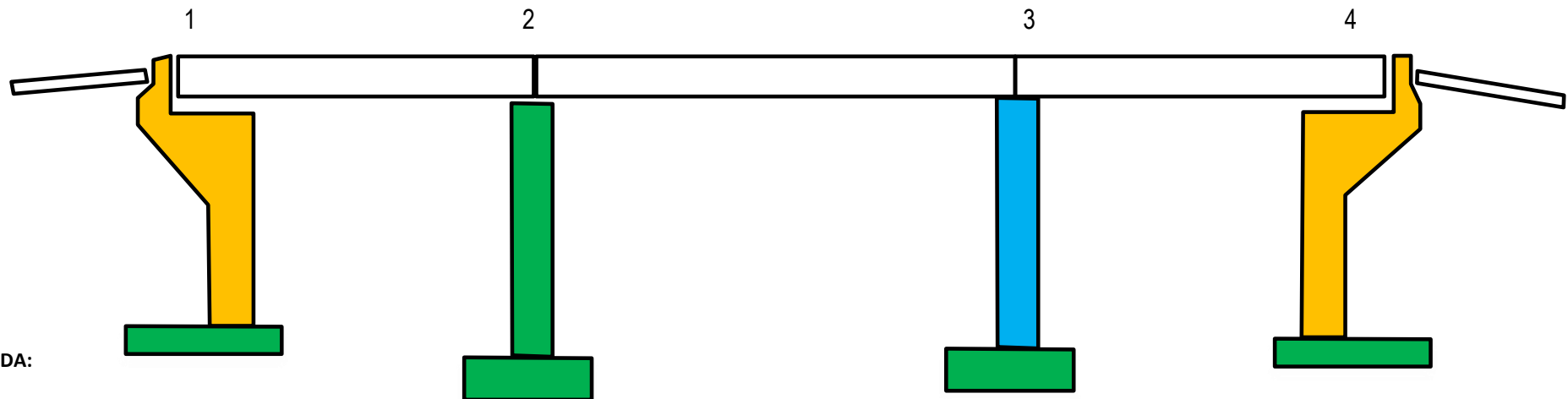

# WD-110

ANTYKOROZJA													
BARIERY													
NAWIERZCHNIA													
ASFALT TWARDOLANY													
KAPY CHODNIKOWE													
KRAWĘŻNIKI													
IZOLACJA ARKUSZOWA													



**LEGENDA:**

-  ROBOTY WYKONANE W BIEŻĄCYM OKRESIE
-  ROBOTY WYKONANE DO BIEŻĄCEGO OKRESU
-  ROBOTY W TOKU W BIEŻĄCYM OKRESIE

## WD-111 JEZDZIA LEWA

ANTYKOROZJA							
BARIERY							
NAWIERZCHNIA							
ASFALT TWARDOLANY							
KAPY CHODNIKOWE							
KRAWĘŻNIKI							
IZOLACJA ARKUSZOWA							



**LEGENDA:**

- ROBOTY W TOKU W BIEŻĄCYM OKRESIE
- ROBOTY WYKONANE W BIEŻĄCYM OKRESIE
- ROBOTY WYKONANE DO BIEŻĄCEGO OKRESU

## WD-111 JEZDZIA PRAWA

ANTYKOROZJA							
BARIERY							
NAWIERZCHNIA							
ASFALT TWARDOLANY							
KAPY CHODNIKOWE							
KRAWĘŻNIKI							
IZOLACJA ARKUSZOWA							

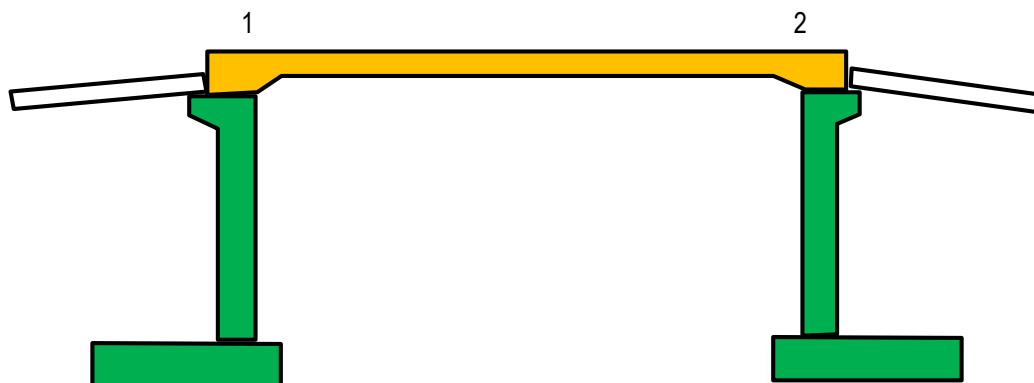

WD-112 JEZDNIĄ LEWA

- LEGENDA:**
- ROBOTY WYKONANE W BIEŻĄCYM OKRESIE
  - ROBOTY WYKONANE DO BIEŻĄCEGO OKRESU
  - ROBOTY W TOKU W BIEŻĄCYM OKRESIE

ANTYKOROZJA														
BARIERY														
NAWIERZCHNIA														
ASFALT TWARDOŚCI														
KAPY CHODNIKOWE														
KRAWĘŻNIE														
ISOLACJA AKRYSZOWA														

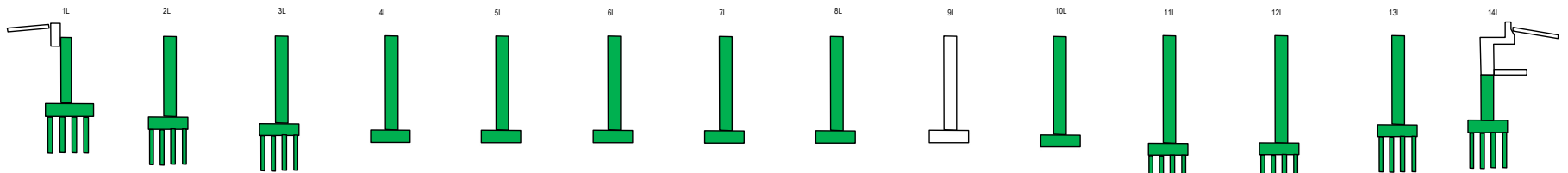

WD-112 JEZDNIĄ PRAWA

- LEGENDA:**
- ROBOTY WYKONANE W BIEŻĄCYM OKRESIE
  - ROBOTY WYKONANE DO BIEŻĄCEGO OKRESU
  - ROBOTY W TOKU W BIEŻĄCYM OKRESIE

ANTYKOROZJA														
BARIERY														
NAWIERZCHNIA														
ASFALT TWARDOŚCI														
KAPY CHODNIKOWE														
KRAWĘŻNIE														
ISOLACJA AKRYSZOWA														

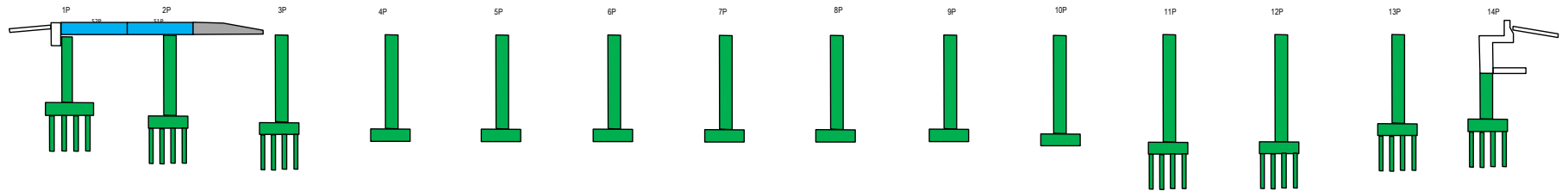

WD-113 JEZDNIA LEWA

ANTYKOROZJA																					
BARIERY																					
NAWIERZCHNIA																					
ASFALT TWARDOLANY																					
KAPY CHODNIKOWE																					
KRAWĘŻNIKI																					
IZOLACJA ARKUSZOWA																					

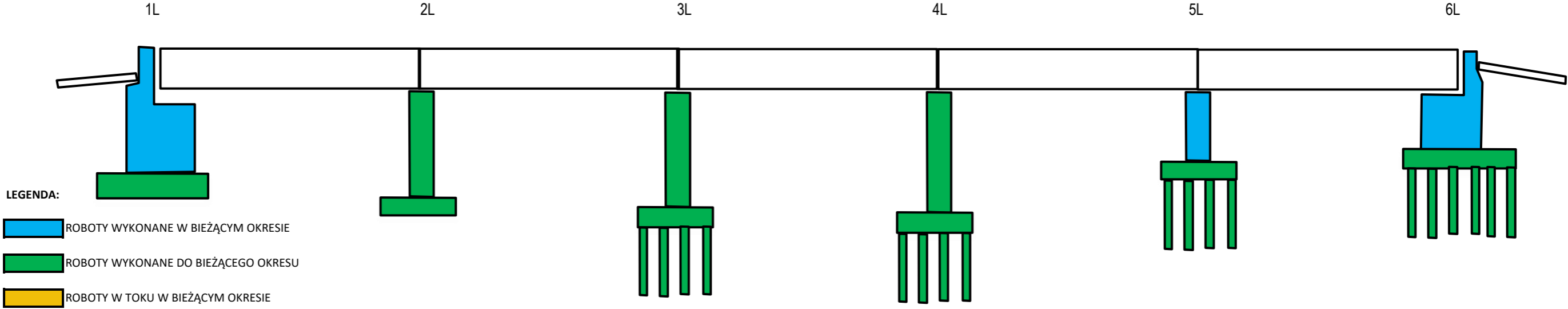

WD-113 JEZDNIA PRAWA

ANTYKOROZJA																					
BARIERY																					
NAWIERZCHNIA																					
ASFALT TWARDOLANY																					
KAPY CHODNIKOWE																					
KRAWĘŻNIKI																					
IZOLACJA ARKUSZOWA																					

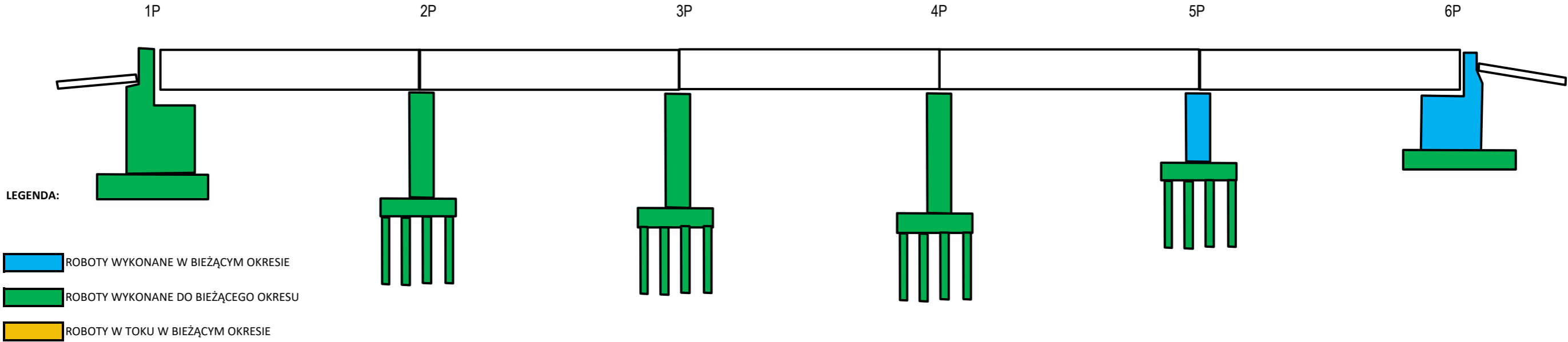



# WD-113B

ANTYKOROZJA												
BARIERY												
NAWIERZCHNIA												
ASFALT TWARDOLANY												
KAPY CHODNIKOWE												
KRAWĘŻNIKI												
IZOLACJA ARKUSZOWA												

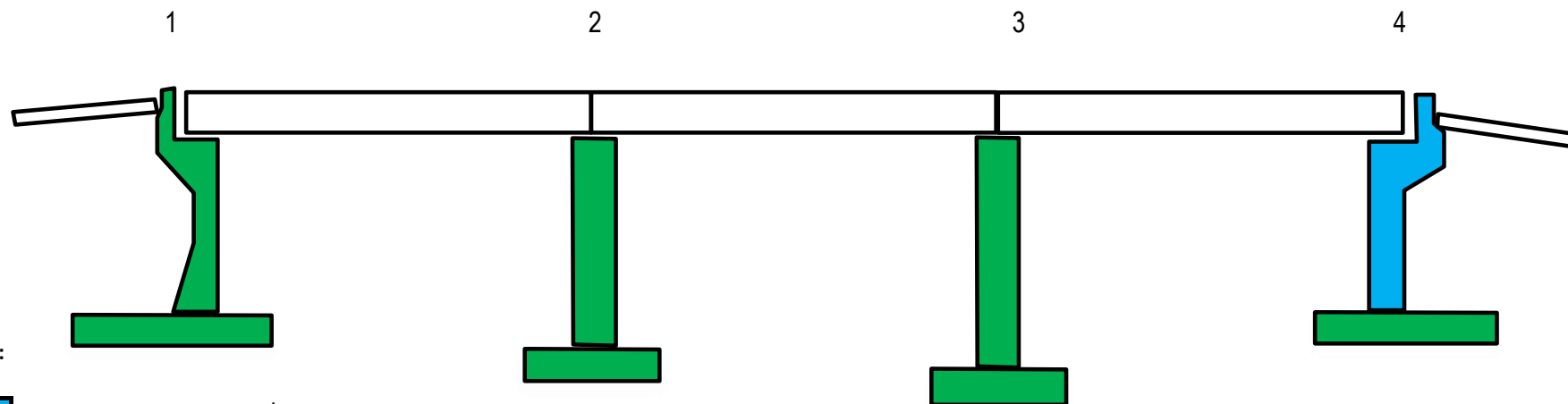

**LEGENDA:**



- ROBOTY WYKONANE W BIEŻĄCYM OKRESIE
- ROBOTY WYKONANE DO BIEŻĄCEGO OKRESU
- ROBOTY W TOKU W BIEŻĄCYM OKRESIE

# WD-114

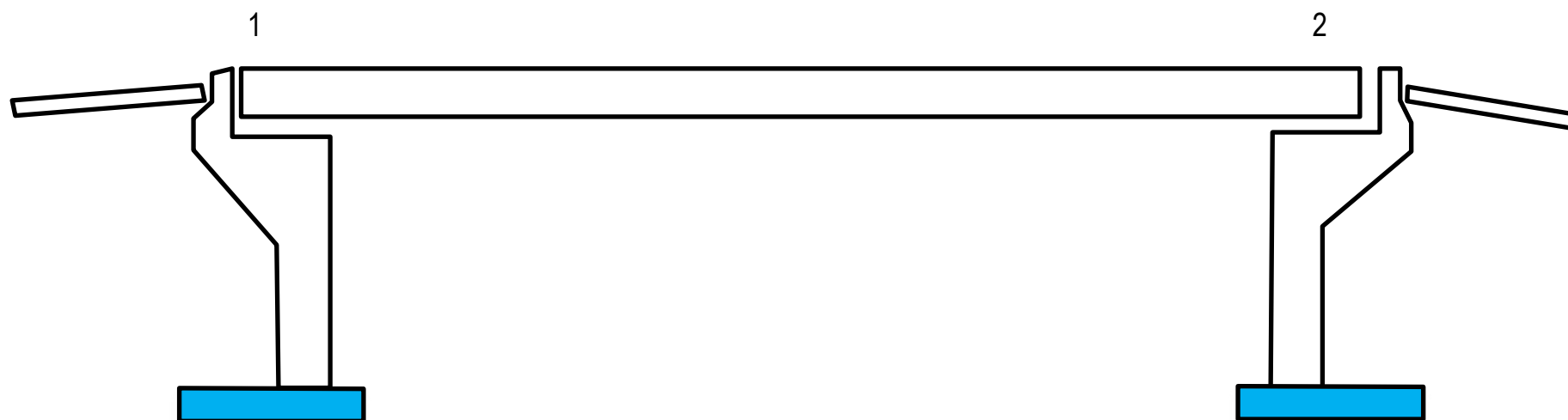
ANTYKOROZJA										
BARIERY										
NAWIERZCHNIA										
ASFALT TWARDOLANY										
KAPY CHODNIKOWE										
KRAWĘŻNIKI										
IZOLACJA ARKUSZOWA										



## LEGENDA:

-  ROBOTY WYKONANE W BIEŻĄCYM OKRESIE
-  ROBOTY WYKONANE DO BIEŻĄCEGO OKRESU
-  ROBOTY W TOKU W BIEŻĄCYM OKRESIE

## WD-115 strona prawa

ANTYKOROZJA							
BARIERY							
NAWIERZCHNIA							
ASFALT TWARDOLANY							
KAPY CHODNIKOWE							
KRAWĘŻNIKI							
IZOLACJA ARKUSZOWA							

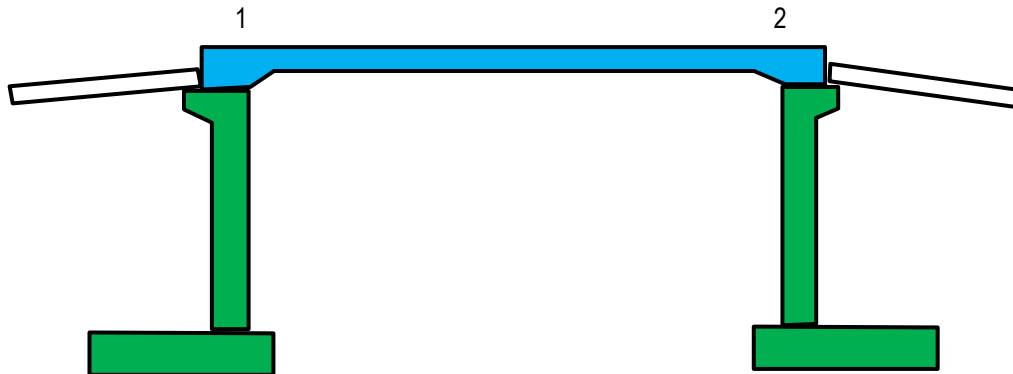

**LEGENDA:**

- ROBOTY WYKONANE W BIEŻĄCYM OKRESIE
- ROBOTY WYKONANE DO BIEŻĄCEGO OKRESU
- ROBOTY W TOKU W BIEŻĄCYM OKRESIE

## WD-115 strona lewa

ANTYKOROZJA							
BARIERY							
NAWIERZCHNIA							
ASFALT TWARDOLANY							
KAPY CHODNIKOWE							
KRAWĘŻNIKI							
IZOLACJA ARKUSZOWA							

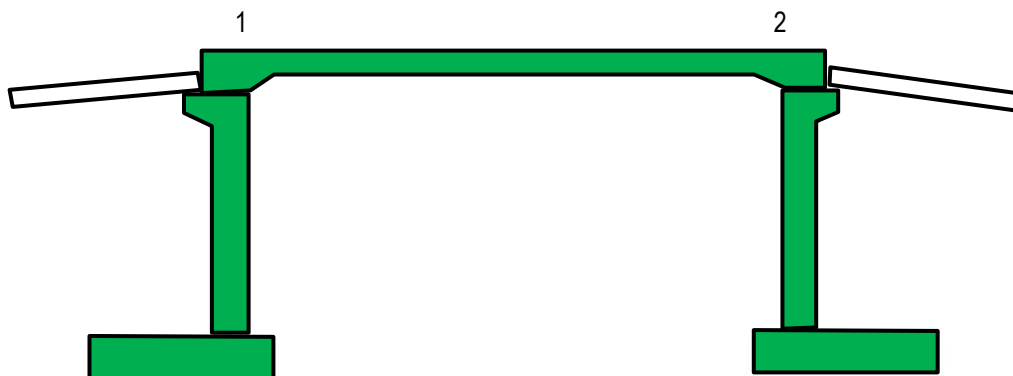

**LEGENDA:**

- ROBOTY WYKONANE W BIEŻĄCYM OKRESIE
- ROBOTY WYKONANE DO BIEŻĄCEGO OKRESU
- ROBOTY W TOKU W BIEŻĄCYM OKRESIE



### WD-116 JEZDZIA LEWA

ANTYKOROZJA											
BARIERY											
NAWIERZCHNIA											
ASFALT TWARDOLANY											
KAPY CHODNIKOWE											
KRAWĘŻNIKI											
IZOLACJA ARKUSZOWA											

1L

2L

3L

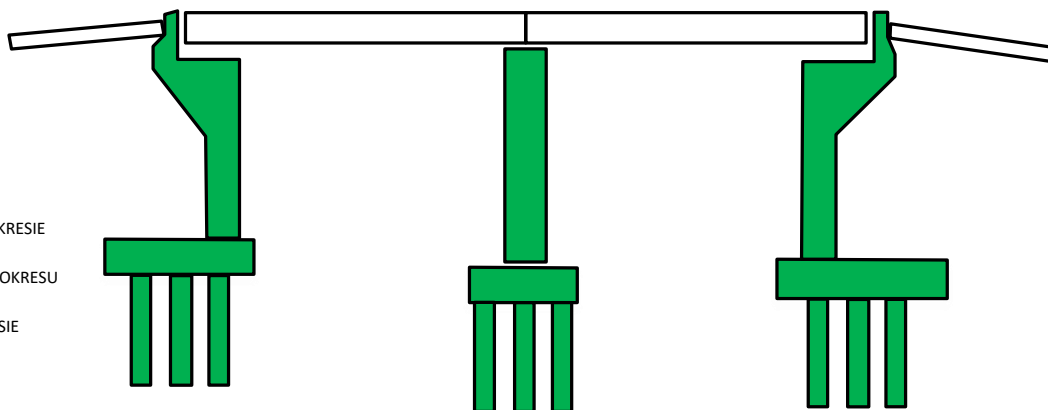

**LEGENDA:**

- ROBOTY WYKONANE W BIEŻĄCYM OKRESIE
- ROBOTY WYKONANE DO BIEŻĄCEGO OKRESU
- ROBOTY W TOKU W BIEŻĄCYM OKRESIE

### WD-116 JEZDZIA PRAWA

ANTYKOROZJA											
BARIERY											
NAWIERZCHNIA											
ASFALT TWARDOLANY											
KAPY CHODNIKOWE											
KRAWĘŻNIKI											
IZOLACJA ARKUSZOWA											

1P

2P

3P

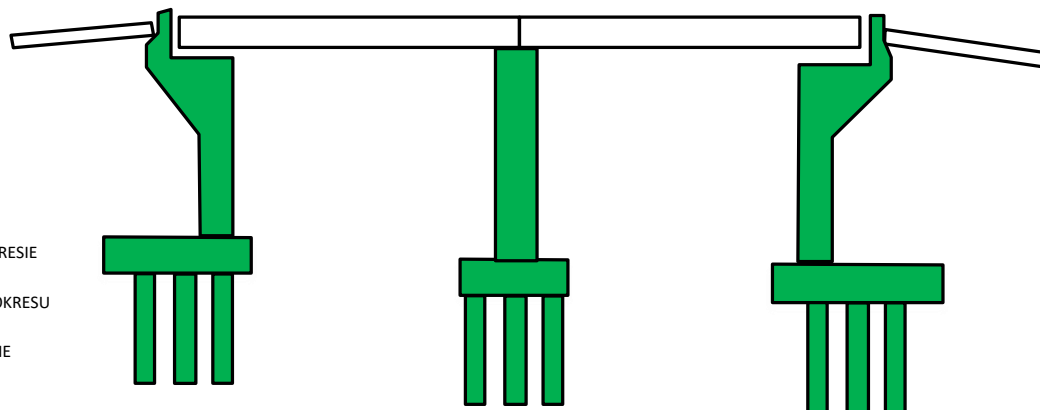

**LEGENDA:**

- ROBOTY WYKONANE W BIEŻĄCYM OKRESIE
- ROBOTY WYKONANE DO BIEŻĄCEGO OKRESU
- ROBOTY W TOKU W BIEŻĄCYM OKRESIE



### WD-118 JEZDNIĄ LEWA

ANTYKOROZJA									
BARIERY									
NAWIERZCHNIA									
ASFALT TWARDOLANY									
KAPY CHODNIKOWE									
KRAWĘŻNIKI									
IZOLACJA ARKUSZOWA									



LEGENDA:

- ROBOTY WYKONANE W BIEŻĄCYM OKRESIE
- ROBOTY WYKONANE DO BIEŻĄCEGO OKRESU
- ROBOTY W TOKU W BIEŻĄCYM OKRESIE

### WD-118 JEZDNIĄ PRAWA

ANTYKOROZJA									
BARIERY									
NAWIERZCHNIA									
ASFALT TWARDOLANY									
KAPY CHODNIKOWE									
KRAWĘŻNIKI									
IZOLACJA ARKUSZOWA									



### MD-119 JEZDNIA LEWA

**LEGENDA:**

- ROBOTY WYKONANE W BIEŻĄCYM OKRESIE
- ROBOTY WYKONANE DO BIEŻĄCEGO OKRESU
- ROBOTY W TOKU W BIEŻĄCYM OKRESIE

ANTYKOROZJA											
BARIERY											
NAWIERZCHNIA											
ASFALT TWARDOLIANY											
KAPY CHODNIKOWE											
KRAWĘŻNIKI											
IZOLACJA ARKUSZOWA											

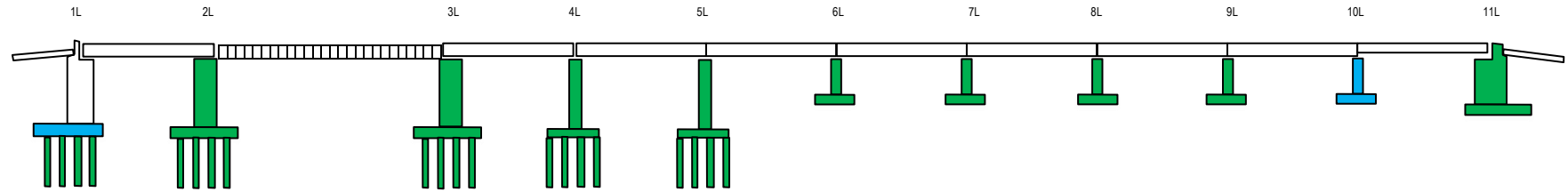

### MD-119 JEZDNIA PRAWA

**LEGENDA:**

- ROBOTY WYKONANE W BIEŻĄCYM OKRESIE
- ROBOTY WYKONANE DO BIEŻĄCEGO OKRESU
- ROBOTY W TOKU W BIEŻĄCYM OKRESIE

ANTYKOROZJA											
BARIERY											
NAWIERZCHNIA											
ASFALT TWARDOLIANY											
KAPY CHODNIKOWE											
KRAWĘŻNIKI											
IZOLACJA ARKUSZOWA											

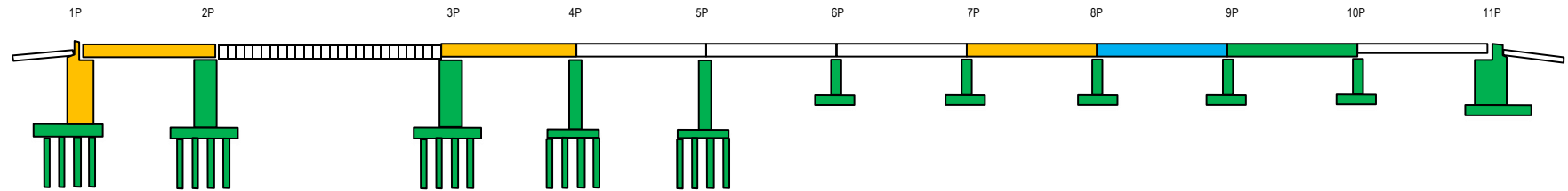

**WD-120 strona lewa**

ANTYKOROZJA									
BARIERY									
NAWIERZCHNIA									
ASFALT TWARDOLANY									
KAPY CHODNIKOWE									
KRAWĘŻNIKI									
IZOLACJA ARKUSZOWA									

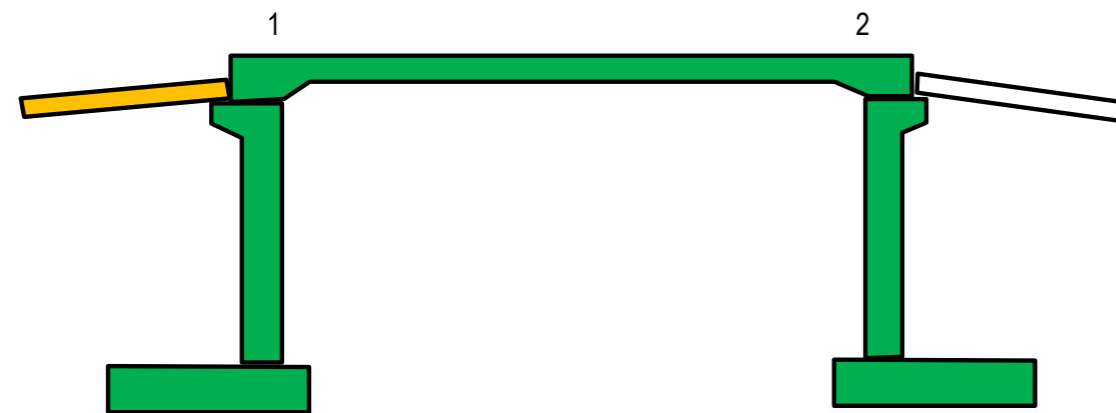

LEGENDA:

- ROBOTY WYKONANE W BIEŻĄCYM OKRESIE
- ROBOTY WYKONANE DO BIEŻĄCEGO OKRESU
- ROBOTY W TOKU W BIEŻĄCYM OKRESIE

**WD-120 strona prawa**

ANTYKOROZJA									
BARIERY									
NAWIERZCHNIA									
ASFALT TWARDOLANY									
KAPY CHODNIKOWE									
KRAWĘŻNIKI									
IZOLACJA ARKUSZOWA									

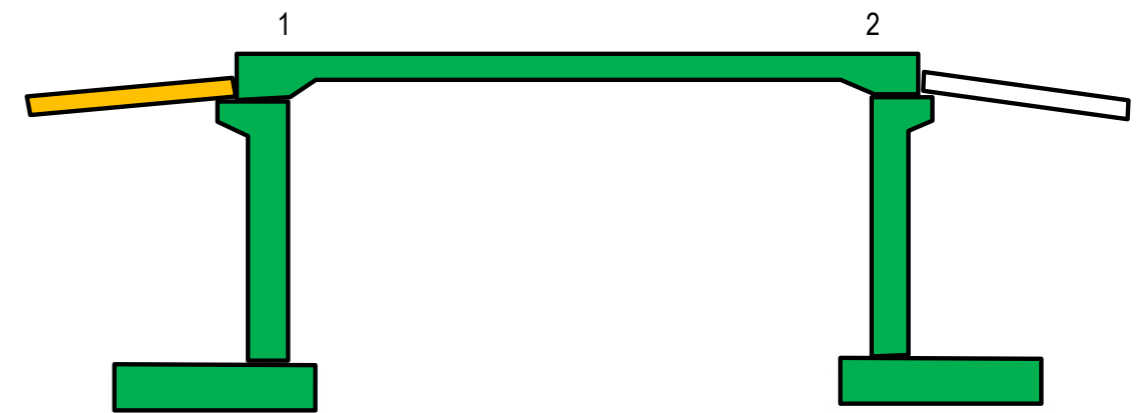





# WD-122A

ANTYKOROZJA																				
BARIERY																				
NAWIERZCHNIA																				
ASFALT TWARDOLANY																				
KAPY CHODNIKOWE																				
KRAWĘŻNIKI																				
IZOLACJA ARKUSZOWA																				

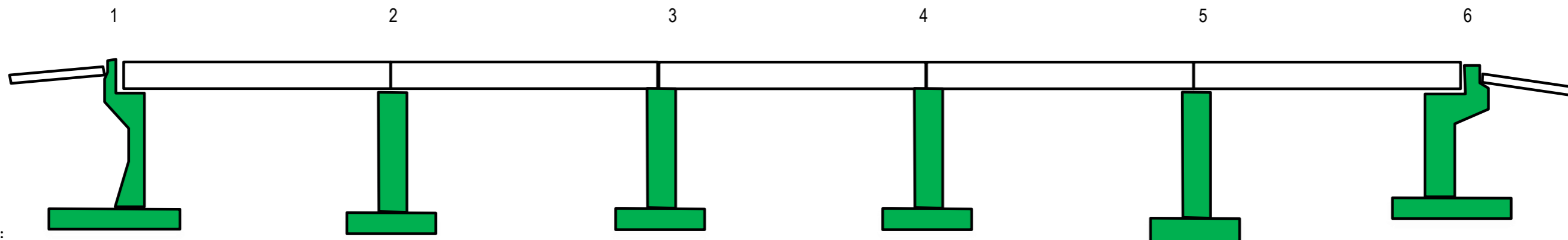

## LEGENDA:

- ROBOTY WYKONANE W BIEŻĄCYM OKRESIE
- ROBOTY WYKONANE DO BIEŻĄCEGO OKRESU
- ROBOTY W TOKU W BIEŻĄCYM OKRESIE



### WD-122B

ANTYKOROZJA																				
BARIERY																				
NAWIERZCHNIA																				
ASFALT TWARDOLANY																				
KAPY CHODNIKOWE																				
KRAWĘŻNIKI																				
IZOLACJA ARKUSZOWA																				

1

2

3

4

5

6



**LEGENDA:**

ROBOTY WYKONANE W BIEŻĄCYM OKRESIE

ROBOTY WYKONANE DO BIEŻĄCEGO OKRESU

ROBOTY W TOKU W BIEŻĄCYM OKRESIE

